

ADVANCED NETWORK SETUP

For wired network camera

Please read instructions thoroughly before operation and retain it for future reference.

IMPORTANT SAFEGUARD



All lead-free products offered by the company comply with the requirements of the European law on the Restriction of Hazardous Substances (RoHS) directive, which means our manufacture processes and products are strictly "lead-free" and without the hazardous substances cited in the directive.



The crossed-out wheeled bin mark symbolizes that within the European Union the product must be collected separately at the product end-of-life. This applies to your product and any peripherals marked with this symbol. Do not dispose of these products as unsorted municipal waste. Contact your local dealer for procedures for recycling this equipment.



This apparatus is manufactured to comply with the radio interference requirements.

Federal Communications Commission Interference Statement

This equipment has been tested and found to comply with the limits for a Class B digital service, pursuant to Part 15 of the FCC rules. These limits are designed to provide reasonable protection against harmful interference in a residential installation.

Any changes or modifications made to this equipment may void the user's authority to operate this equipment. This equipment generates, uses, and can radiate radio frequency energy. If not installed and used in accordance with the instructions, may cause harmful interference to radio communications. However, there is no guarantee that interference will not occur in a particular installation. If this equipment does cause harmful interference to radio or television reception, which can be determined by turning the equipment off and on, the user is encouraged to try to correct the interference by one or more of the following measures:

- Reorient or relocate the receiving antenna.
- Increase the separation between the equipment and receiver.
- Connect the equipment into an outlet on a circuit different from that to which the receiver is connected.
- Consult the dealer or an experienced radio/TV technician for help.
- FCC Caution: Any changes or modifications not expressly approved by the party responsible for compliance could void the user's authority to operate this equipment.
- All external cables connecting to this basic unit must be shielded.

For cables connecting to PCMCIA cards, see the option manual or installation instructions.

This device complies with Part 15 of the FCC Rules. Operation is subject to the following two conditions:

- (1) This device may not cause harmful interference, and
- (2) This device must accept any interference received, including interference that may cause undesired operation.

Trademark Acknowledgements

iPad® & iPhone® are the registered trademarks of Apple Inc.

Android™ is a trademark of Google Inc. Use of this trademark is subject to Google Permissions.

Microsoft®, Windows® & Internet Explorer® are registered trademarks of Microsoft Corporation in the United States and/or other countries.

Disclaimer

We reserve the right to revise or remove any content in this manual at any time. We do not warrant or assume any legal liability or responsibility for the accuracy, completeness, or usefulness of this manual. The content of this manual is subject to change without notice.

This product doesn't have a standby / off mode.

MPEG4 Licensing

THIS PRODUCT IS LICENSED UNDER THE MPEG4 VISUAL PATENT PORTFOLIO LICENSE FOR THE PERSONAL AND NON-COMMERCIAL USE OF A CONSUMER FOR (i) ENCODING VIDEO IN COMPLIANCE WITH THE MPEG4 VISUAL STANDARD ("MPEG-4 VIDEO") AND/OR (ii) DECODING MPEG4 VIDEO THAT WAS ENCODED BY A CONSUMER ENGAGED IN A PERSONAL AND NON-COMMERCIAL ACTIVITY AND/OR WAS OBTAINED FROM A VIDEO PROVIDER LICENSED BY MPEG LA TO PROVIDE MPEG4 VIDEO. NO LICENSE IS GRANTED OR SHALL BE IMPLIED FOR ANY OTHER USE. ADDITIONAL INFORMATION INCLUDING THAT RELATING TO PROMOTIONAL INTERNAL AND COMMERCIAL USES AND LICENSING MAY BE OBTAINED FROM MPEG LA, LLC. SEE [HTTP://WWW.MPEGLA.COM](http://www.mpegla.com).

TABLE OF CONTENTS

1. Check Your Network Environment	5
2 Wireless Router + Modem	6
2.1 Configure on Laptop / Computer	6
2.2 Configure with iOS devices (iPhone / iPad)	8
2.3 Configure with Android mobile devices	10
3 Router + Modem	13
4 Modem / Hub + Modem	15
5 Change Default Account	18
5.1 From Web Browser	18
5.2 From iOS devices (iPhone / iPad) / Android mobile devices	18
APPENDIX 1 CHANGE IP ADDRESS OF YOUR LAPTOP / PC	19
APPENDIX 2 MOBILE SURVEILLANCE VIA EAGLEEYES	22
A2.1 Prerequisites	22
A2.2 Where to download	22
APPENDIX 3 CONFIGURE PORT FORWARDING	23

1. Check Your Network Environment

Please follow the instructions below to finish camera installation and network configurations.

Check your network environment and see which category you have:

1. Wireless router + Modem

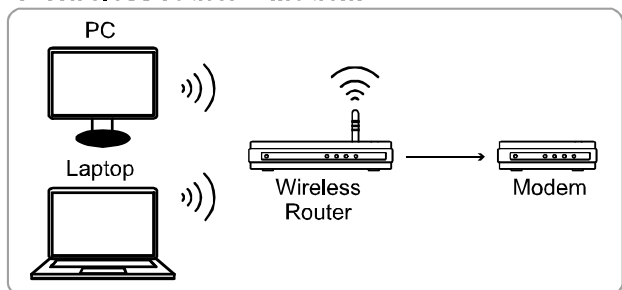

→ Devices connected with a network cable))) Devices connected wirelessly

2. Router + Modem

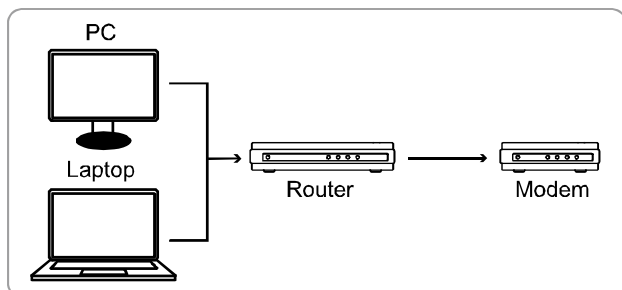

3. Modem or Modem + Hub

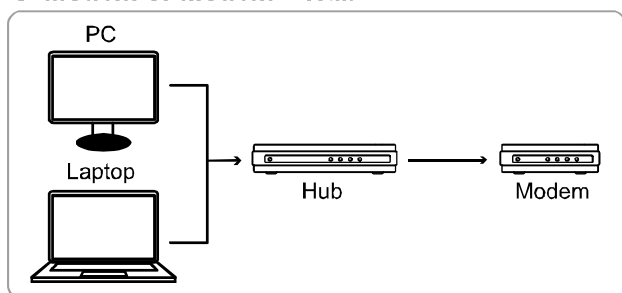

→ Devices connected with a network cable

If you're using:

- Wireless router + modem, please refer to "2 Wireless Router + Modem".
- Router + modem, please refer to "3 Router + Modem".
- Modem or modem + hub, please refer to "4 Modem / Hub + Modem".

When your camera is connected to Internet, it's also recommended to change the password of the default account. For details, please refer to "5 Change Default Account".

Then, connect your network camera directly to your wireless router / router / hub / modem with a network cable, and power it on.

2 Wireless Router + Modem

You may use your laptop / computer, or your iOS (iPhone / iPad) and Android mobile device to complete the network configuration of the camera.

Note: Network setup with your iOS (iPhone / iPad) and Android mobile device is available only for EaZy Networking, Push Video, and ETS camera series. If your network camera doesn't belong to any of the three series, please finish the setup with your laptop / computer.

2.1 Configure on Laptop / Computer

Before configuring this camera on your laptop / PC, make sure:

- Your Windows operating system is Windows 7, Vista or XP.
- (Recommended) Your wireless router supports UPnP, and this function is enabled.

Note: If your wireless router doesn't support UPnP, you need to additionally access your router for port forwarding. For details, please refer to "APPENDIX 3 CONFIGURE PORT FORWARDING" at page 23.

- You have noted down the IP address of your router, and the assigned IP address(es) and port(s) of other devices connected to the same router.

Note: For details, please refer to the user manual of your wireless router, or check with your installer.

- You have downloaded "IPScan.exe" in your laptop / computer.

Note: Please download "IPScan.exe" from [HERE](#).

Step1: Connect your network camera directly to your wireless router with a network cable, and power it on.

Step2: Connect your laptop / PC to the wireless network with the camera connected.

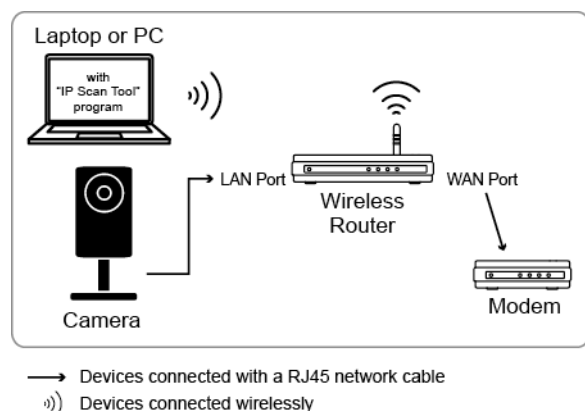

Step3: Open "IPScan.exe" (🔍) to search your camera, and:

- Note down the IP address and port number after search, such as "192.168.2.25" and "88" in our example.
- Select the IP address, and click "Configure" to note down the gateway IP address. It's the address of your wireless router, and you might need it later for port forwarding.
- Change the port you're using for this camera to other value (such as "8080") in "Web Port" if you know the default port number "88" is blocked by your Internet service provider or phone carrier. Then, enter the user name (admin) and password (admin) to confirm.

The number of "80" is not recommended to use since some Internet service providers and phone carriers might block the use of "80".

192.168.2.25:
IP address assigned by
your wireless router

GateWay:
The IP address of
your wireless router

Web Port:
Keep the default value "88",
or change it to other value
(such as 8080) if the port
number of 88 is blocked by
your service provider.

Step4: Open Internet Explorer on your laptop / computer, and enter the IP address and port number you just found in the URL column to access this camera.

The format is <http://ipaddress:portnum>, such as <http://192.168.2.25:88> in our example.

In the login page, enter the user name, password, and security code to access.

Note: Please skip the wizard.

Step5: Go to "Config." → "DDNS", and enable the DDNS service.

- If your router supports UPnP, please proceed Step5.
- If your router doesn't support UPnP, note down the host name, such as *MAC000e531d6ff1.ddns.eagleeyes.tw*, and click "Save". Then, access your wireless router for port forwarding as instructed in "APPENDIX 3 CONFIGURE PORT FORWARDING" at page 23.

Step6: Go to "UPnP", and enable the UPnP service.

Then, enable "Port Mapping", and click "Save" to start port mapping automatically.

When the configurations are saved successfully, you'll see a message indicating the IP address and port number assigned to your camera.

Note down the IP address and port number, and log out the camera.

Check your connection

Step1: Connect your laptop / computer to Internet with the wireless network other than the one this camera is connected.

Step2: Enter the IP address or host name you just noted down and the port number in the URL address box of the web browser, and see if you can enter the login page of the camera successfully.

The format is "**http://ipaddress:portnum**" or "**http://hostname:portnum**".

2.2 Configure with iOS devices (iPhone / iPad)

Before configuring this camera on iPhone / iPad, make sure:

- You've installed our mobile app, **EagleEyes**, in your iPhone / iPad.

Note: If you haven't installed **EagleEyes**, please go to "App Store" and search "eagleeyes". The free version of EagleEyes is *EagleEyes (Lite)* for Android 1.6 (or later) or *EagleEyes(Lite+)* for Android 2.2 (or later).

For more details, please refer to "APPENDIX 2 MOBILE SURVEILLANCE VIA EAGLEEYES" at page 22, or visit www.eagleeyesccv.com.

- (Recommended) Your wireless router supports UPnP, and this function is enabled.

Note: If your wireless router doesn't support UPnP, you need to additionally access your router for port forwarding. For details, please refer to "APPENDIX 3 CONFIGURE PORT FORWARDING" at page 23.

- Your camera is connected to your wireless router with a RJ45 network cable, and it's powered on.
- You have checked the IP address used by your wireless router with the camera connected as instructed below, and written it down. You'll need it later.

Connect your iPhone / iPad to the wireless router with the camera connected, and go to "Settings" → "Wi-Fi". Select ">" near the selected wireless network to enter the details.

The IP address shown in "Router" is the IP address used by your wireless router. In the following example, the IP address of your router is *192.168.2.1*.



Note: This address will be needed when you want to access your router for port forwarding later.

Note: The screenshots of EagleEyes shown in this chapter are taking from *EagleEyes - lite*. The actual display may differ from *EagleEyesHD Lite*, but it's similar.

Then, follow the steps below to configure your camera to Internet.

Step1: Connect your iPhone to the wireless router which has the camera connected.

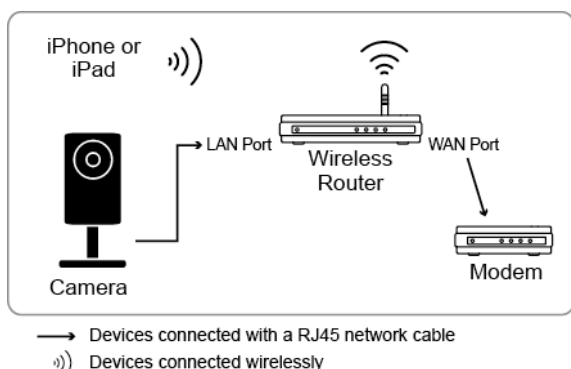

Step2: Open "EagleEyes" on your iPhone or iPad.

In the address book, click "+" to add new device. Then, select "Local Network Search" to search your network camera. You'll see an IP address assigned by your router.

If you connect two or more cameras to the wireless router, you'll see many cameras with different IP addresses after searching. To know which camera you're configuring, you may identify each with its unique MAC address.

Note: The MAC address can be found on the sticker at the rear panel of the camera.

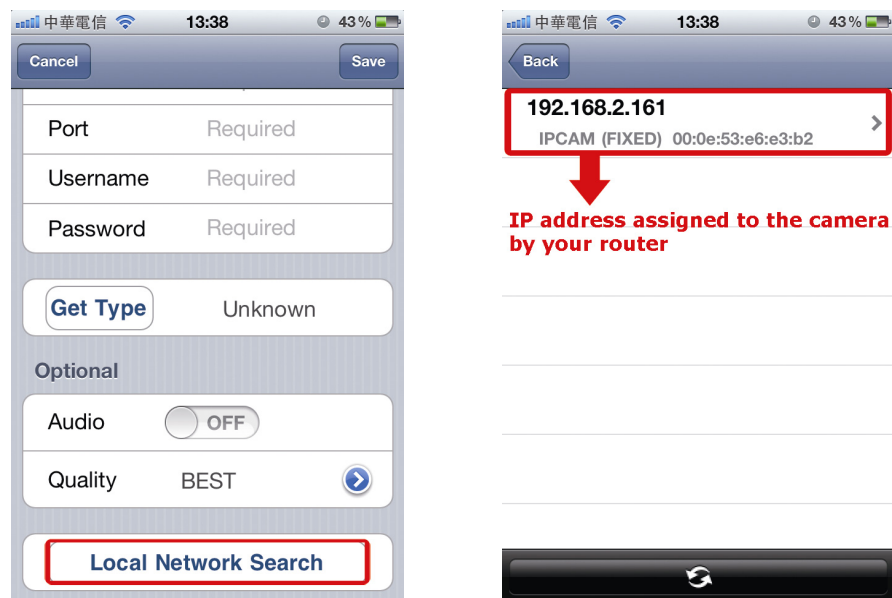

Step3: Select the IP address you want to configure to show the IP address setting page.

Switch the tab from "DHCP" to "Static".

The default port number is 88. You may change it to any value (such as 8080) if the port number of 88 is blocked.

Then, note down the IP address and port number you see here. You might need them for port forwarding later.

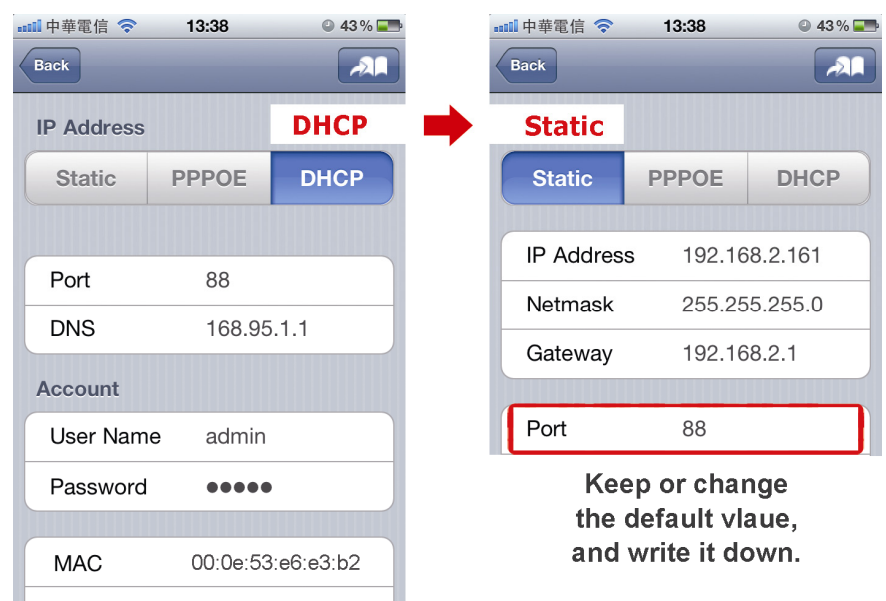

Step4: Select "Apply" to confirm all your changes. Then, wait till you see "Done" or "Fail" in "Status".

Regardless which message you see, proceed as instructed below:

- For **Done**, you'll return to the new device page.
- For **Fail**, select "Back" on the top right side. You'll later be prompted to select "DDNS" or "Local IP". Select "DDNS" and return to the new device page.

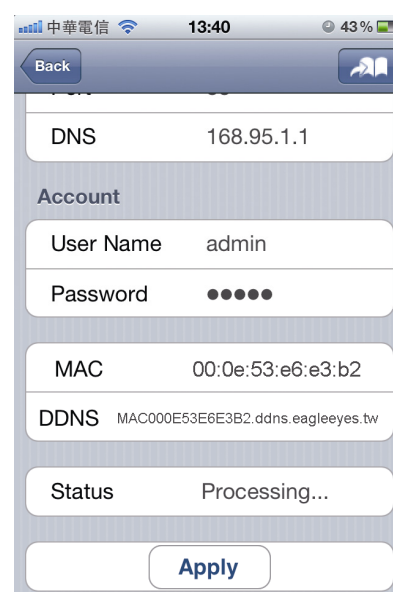

Status Change
When Selecting "Apply":
Processing...
↓
"Done" or "Fail"

Step5: In the new device page, give a meaningful name for this connection in “Title”, and click “Save”.

Please continue with configuring port forwarding as instructed in “APPENDIX 3 CONFIGURE PORT FORWARDING” at page 23.

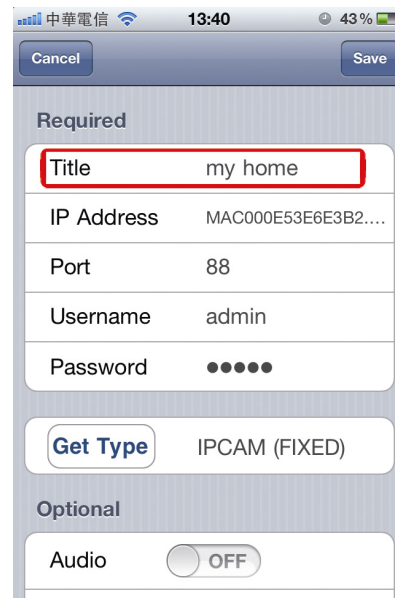

Check your connection

Step1: Switch the network mode to 3G mode on iPhone or iPad.

Step2: Start EagleEyes, and select the connection you just added to see if you can access the camera successfully.

- If yes, your network setup is successfully.
- If no, go to Step3.

Step3: Switch your network mode to wireless mode on iPhone or iPad.

Step4: Start EagleEyes, and add a new connection with the IP address (e.g. 192.168.2.25) and the port number (e.g. 88). Then, try this connection and see if you can access the camera successfully.

- If yes, go for port forwarding setting as instructed in “APPENDIX 3 CONFIGURE PORT FORWARDING” at page 23.
- If no, return to Step1 in “2.2 Configure with iOS devices (iPhone / iPad)” and re-configure the network again.

2.3 Configure with Android mobile devices

Before using your Android mobile devices to configure this camera to Internet, make sure:

- The brand of your Android mobile phone is **NOT** HTC.

Note: The **HTC** Android mobile devices do not support this function. Please get another Android mobile device. Otherwise, go to “2.2 Configure with iOS devices (iPhone / iPad)” or “2.1 Configure on Laptop / Computer” to configure your camera to Internet in other ways.

- You’ve installed our mobile app, **EagleEyes**, in your Android mobile device.

Note: If you haven’t installed **EagleEyes**, please go to “App Store” and search “eagleeyes”. The free version of EagleEyes is *EagleEyes (Lite)* for Android 1.6 (or later) or *EagleEyes(Lite+)* for Android 2.2 (or later).

For more details, please refer to “APPENDIX 2 MOBILE SURVEILLANCE VIA EAGLEEYES” at page 22, or visit www.eagleeyesctv.com.

- The camera is installed and powered on.

Then, follow the steps below to configure your camera to Internet.

Step1: Connect your Android device to the same wireless network (SSID) as the camera connected.

Step2: Open “EagleEyes” on your Android device.

In the address book, click “+” to add a new device. Then, select “Local Network Search” to search your network camera. You’ll see an IP address assigned by your router.



Step3: Select the IP address you want to configure to show the IP address setting page.

Then, click the drop-down list of "Network" to change the network type from "DHCP" to "Static".

The default port number is 88. You may change it to any value (such as 8080) if you know the port number of 88 is blocked.

Then, note down the IP address and port number you see here. You might need them for port forwarding later.

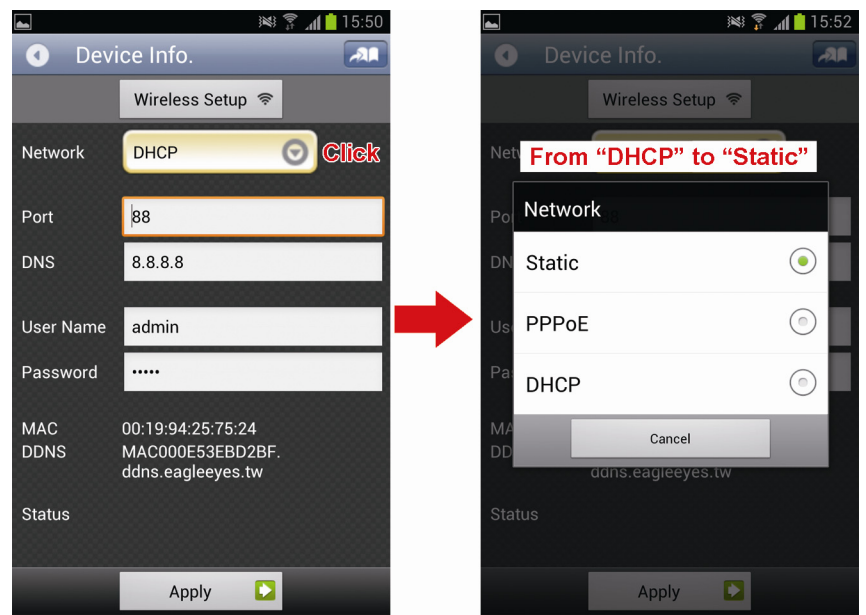

Note: It's not recommended to use the port number of 80 since some phone carriers might block this port for network access.

Step4: Select "Apply" to confirm all your changes. Then, wait till you see "Done" or "Fail" in "Status".

Regardless which message you see, proceed as instructed below:

- For **Done**, you'll return to the new device page.
- For **Fail**, select "🗨️" on the top right side. You'll later be prompted to select "DDNS" or "Local IP". Select "DDNS" and return to the new device page.

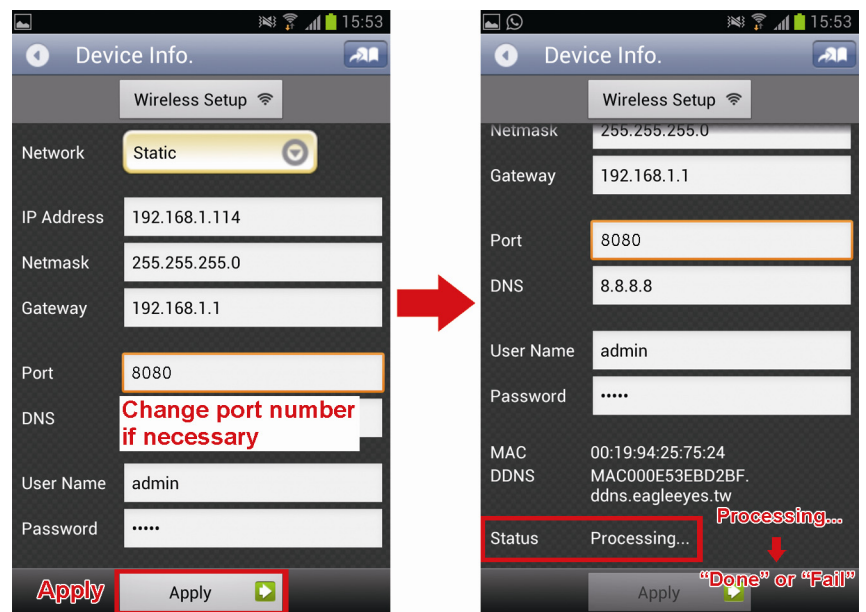

Step5: In the new device page, give a meaningful name for this connection in “Title”, and click “Save”.

Step6: Go to “Check your connection” below to examine your connection.



Check your connection

Step1: Switch the network mode to 3G mode on your android device.

Step2: Start EagleEyes, and select the connection you just added to see if you can access the camera successfully.

- If yes, your network setup is successful.
- If no, go to Step3.

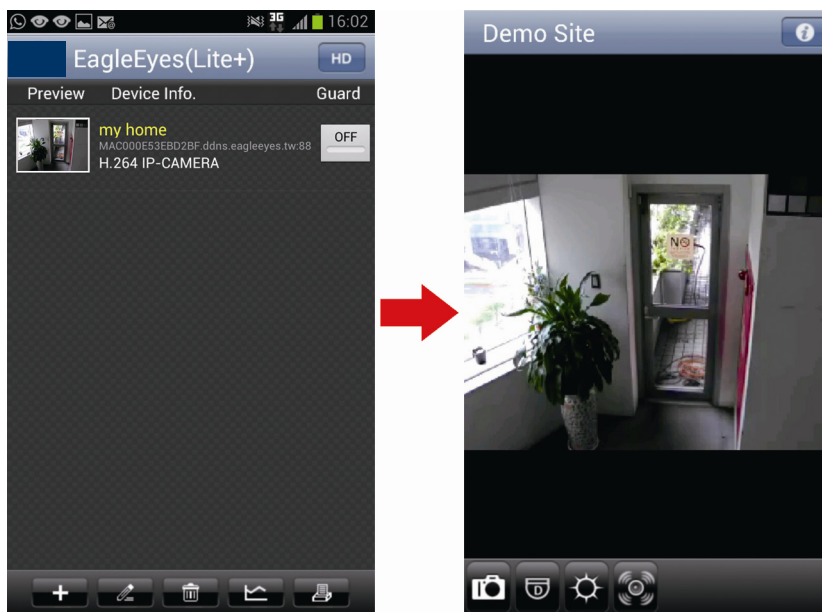

Step3: Switch your network mode to wireless mode on your Android mobile device.

Step4: Start EagleEyes, and add a new connection with the IP address (e.g. 192.168.1.114) and the port number (e.g. 8080). Then, try this connection and see if you can access the camera successfully.

- If yes, go for port forwarding setting as instructed in “APPENDIX 3 CONFIGURE PORT FORWARDING” at page 23.
- If no, return to Step1 in “2.3 Configure with Android mobile devices” and re-configure the network again.

3 Router + Modem

You may use your laptop / PC to complete the network configuration of the camera.

Before configuring this camera on your laptop / PC, make sure:

- Your Windows operating system is Windows 7, Vista or XP.
- (Recommended) Your router supports UPnP, and this function is enabled.

Note: If your wireless router doesn't support UPnP, you need to additionally access your router for port forwarding. For details, please refer to "APPENDIX 3 CONFIGURE PORT FORWARDING" at page 23.

- You have noted down the IP address of your router.

Note: For details, please refer to the user manual of your router, or check with your installer.

- You have downloaded "IPScan.exe" in your laptop / PC.

Note: Please download "IPScan.exe" from [HERE](#).

Step1: Connect your laptop / PC to the router.

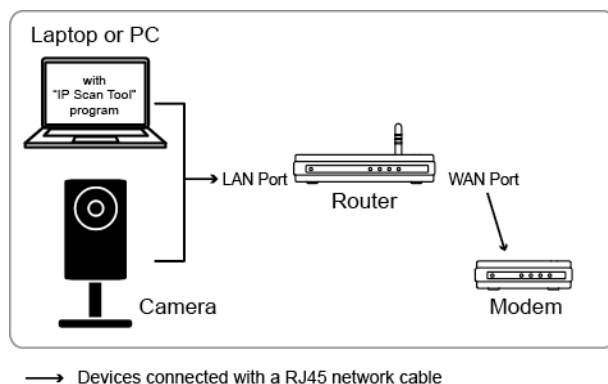

Step2: Open "IPScan.exe" (🔍) to search your camera, and:

- Note down the IP address and port number after search, such as "192.168.2.25" and "88" in our example.
- Select the IP address, and click "Configure" to note down the gateway IP address. It's the address of your wireless router, and you might need it later for port forwarding.
- Change the port you're using for this camera to other value (such as "8080") in "Web Port" if you know the default port number "88" is blocked by your Internet service provider or phone carrier. Then, enter the user name (admin) and password (admin) to confirm.

The number of "80" is not recommended to use since some Internet service providers and phone carriers might block the use of "80".

192.168.2.25:
IP address assigned by your wireless router

IP	Port	Type	Mac
192.168.2.25	88	IP CAMERA (FIX)	00:0e:53:1d:6f:f1

GateWay:
The IP address of your wireless router

Server IP	192 . 168 . 2 . 25	DNS	168 . 95 . 1 . 1
MAC Address	00:0e:53:1d:6f:f1	Web Port	88
NetMask	255 . 255 . 255 . 0	User Name	admin
GateWay	192 . 168 . 2 . 1	Password	*****

Web Port:
Keep the default value "88", or change it to other value (such as 8080) if the port number of 88 is blocked by your service provider.

Step3: Open Internet Explorer on your laptop / computer, and enter the IP address and port number you just found in the URL column to access this camera.

The format is <http://ipaddress:portnum>, such as <http://192.168.2.25:88> in our example.

In the login page, enter the user name, password, and security code to access.

Note: Please skip the wizard.

Step4: Go to "Config." → "DDNS", and enable the DDNS service.

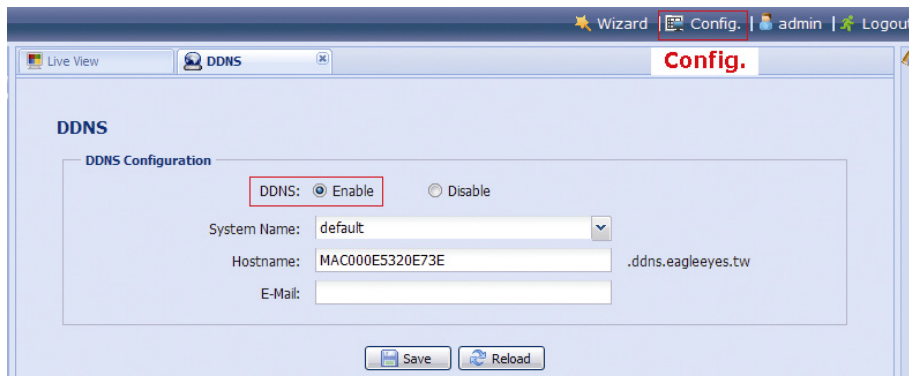

- If your router supports UPnP, please proceed Step7.
- If your router doesn't support UPnP, click "Save", and access your router for port forwarding as instructed in "APPENDIX 3 CONFIGURE PORT FORWARDING" at page 23.

Step5: Go to "UPnP", and enable the UPnP service.

Then, enable "Port Mapping", and click "Save" to start port mapping.

When the configurations are saved successfully, you'll see a message indicating the IP address and port number assigned to your device.

Note down the IP address and port number, and log out the camera.



Check your connection

Step1: Open your web browser, e.g. Internet Explorer.

Step2: Enter the IP address or host name you just noted down and the port number in the URL address box of the web browser, and see if you can access the login page of the camera successfully.

The format is "**http://ipaddress:portnum**" or "**http://hostname:portnum**".

4 Modem / Hub + Modem

You may use your laptop / PC to complete the network configuration of the camera.

Before configuring this camera on your laptop / PC, make sure:

- Your Windows operating system is Windows 7, Vista or XP.
- You have changed the IP address of your laptop / PC to "192.168.1.xxx", where xxx could be 0~255 except 10.

Note: To know how to change the IP address of your laptop / PC, please refer to "APPENDIX 1 CHANGE IP ADDRESS OF YOUR LAPTOP / PC" at page 19.

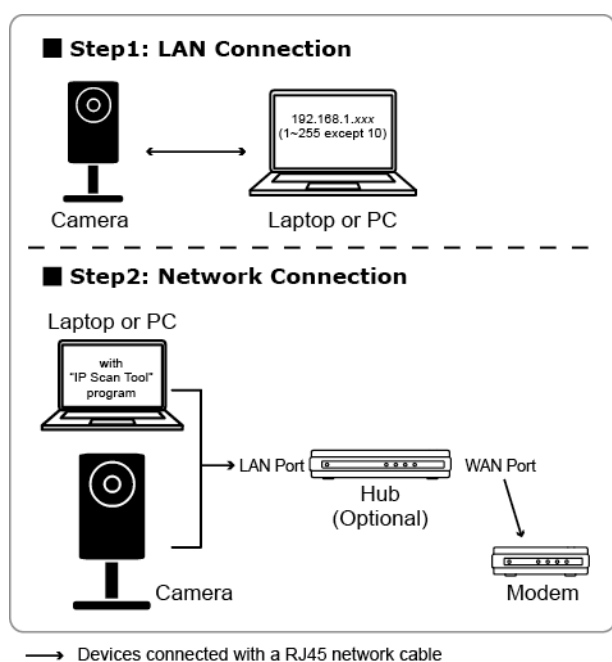

Step1: Disconnect your laptop / PC from the hub or modem, and connect it to this camera with a network cable.

Note: Make sure the IP address of your laptop / PC is changed to "192.168.1.xxx" (1~255 except 10). To know how to change, please refer to "APPENDIX 1 CHANGE IP ADDRESS OF YOUR LAPTOP / PC" at page 19.

Step2: Open the web browser, such as Internet Explorer, on your laptop / PC, and enter "http://192.168.1.10:88" on the URL column to access this camera.

In the login page, enter the user name, password, and security code to access.

Note: The default user name and password for remote access are both "admin".

Step3: The wizard starts to analyze your network environment. When it's completed, select "One Step Wizard" to enter the quick camera setting page.

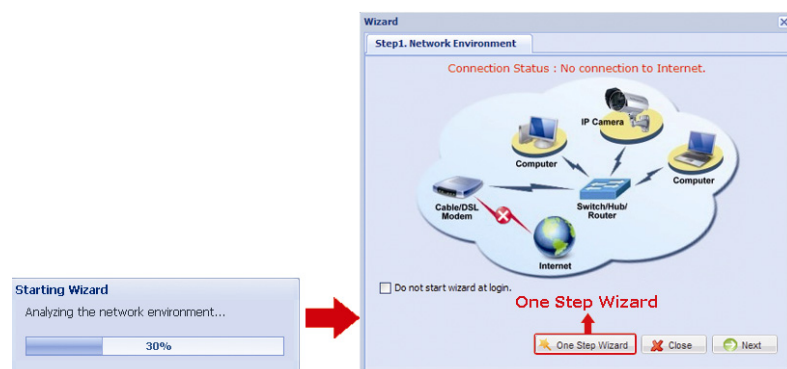

Item	Description
Account	Change your default account password if needed. This change can also be made in “Config.” → “General” → “Account”.
Date and Time	Check and select the current date and time.
Network	Configure your network setting based on the network type you’re using. For details, please refer to Step4 & Step5.

Step4: In “Network”, configure the network setting of your camera based on the network type you’re using. There’re three types: Static IP, PPPOE and DHCP.

For Static IP:

- Enter the information of “Server IP”, “Gateway” and “Net Mask” obtained from your ISP (Internet Service Provider).
- Enter the port number. The valid number ranges from 1 to 9999. The default value is 88.
- Click “Save” to save your network configurations, and log out.
- Disconnect your camera and your PC, and connect them to Internet separately. Then, enter the IP address you just note down in the URL address box of the web browser, and see if you can access the camera successfully.

For PPPOE:

- Enter the user name and password obtained from your ISP, and click “Save”.
- Continue the DDNS setting as instructed in Step5.

For DHCP:

- Before selecting this option, you need to finish the DHCP router settings first.
- Get a router and connect it to the Internet via your PC (with Static IP or PPPoE setting). There are different setting methods for different routers. Please refer to their respective user manuals.
- Continue the DDNS setting as instructed in Step5.

Step5: (Optional) Click “DDNS” ( DDNS) to continue setting for PPPOE and DHCP.

- a) Enable DDNS.
- b) Select “default” in “System Name”.
- c) In “Hostname”, keep the default value, i.e. the MAC address of this camera. Then, note down the whole address of the camera, for example, *MAC000e531d6ff1.ddns.eagleeyes.tw*.
- d) (Optional) Enter your email address to receive messages from the DDNS server.

Note: Please at least use the default address to access your network camera remotely once. This is to ensure our DDNS server has your camera registered. Then, you may change the host name to a more meaningful name to memorize later here.

- e) Click “Save” to return to the network setting page. Then, click “Next”.

Step6: Check if the changes you’ve made are correct, and click “Save” to complete.

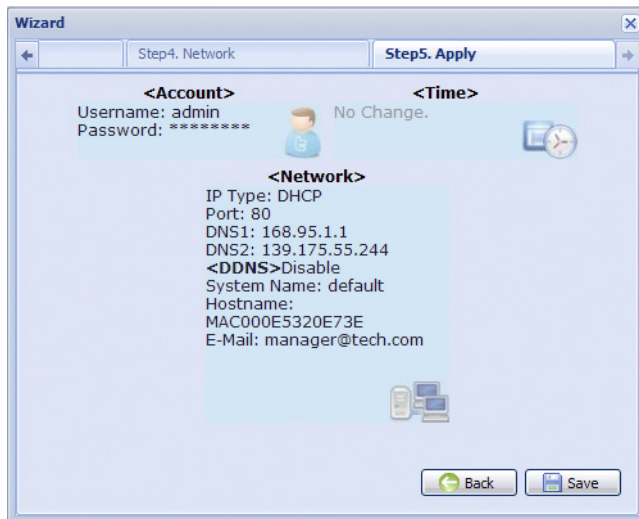

Check your connection

Step1: Disconnect your camera and your laptop / PC, and connect them to Internet separately.

Note: If you changed the IP address of your laptop / PC for LAN connection, remember to restore it back for Internet access to work properly.

Step2: Enter the host name you just noted down and the port number in the URL address box of the web browser, and see if you can access the login page of the camera successfully.

The format is “*http://hostname:portnum*”.

5 Change Default Account

To ensure your account safety, please access the camera after network configuration to change the default user name and password with new one you prefer.

5.1 From Web Browser

Log into the camera, and select “Config.” → “General” → “Account”.

Select the default account “admin”, and click “Edit” to change the default password.

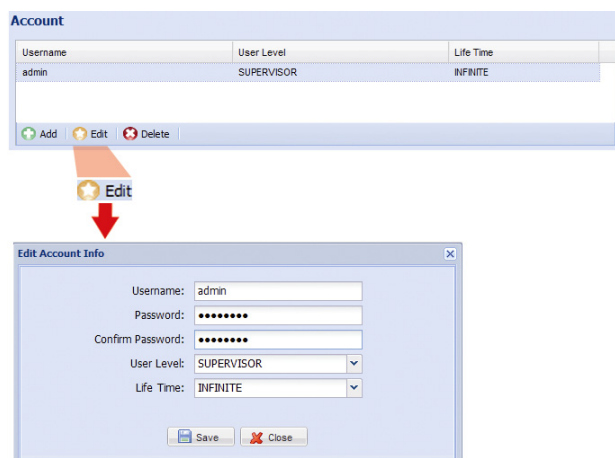

5.2 From iOS devices (iPhone / iPad) / Android mobile devices

In the live view, click “” on the top right corner to enter the quick configuration page.

Scroll down the page, and select “Advanced” to go to the advanced configuration page. Select “Advanced Setup” → “Account”. Then, select the default account “admin”, and click “Edit” to modify the default password.

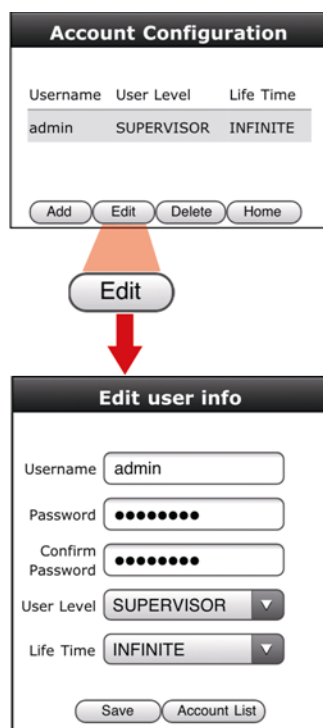

APPENDIX 1 CHANGE IP ADDRESS OF YOUR LAPTOP / PC

For LAN connection with this network camera, you need to change the IP address of your laptop / PC to **192.168.1.xxx** (1~255, except 10) first.

Note: Before changing the IP address, make sure you note down the original IP address setting of your laptop / PC. You need to restore the IP address setting when you complete the network configuration of this camera.

For Windows XP users:

- a) Select “start” → “Control Panel” → “Network and Internet Connections” → “Network Connections” (If you’re in “Category View”).

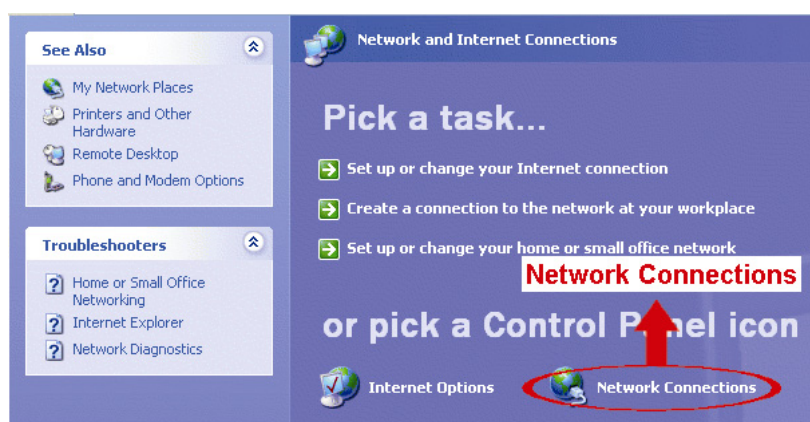

- b) In “LAN or High-Speed Internet”, right-click on “Local Area Connection”, and select “Properties”.

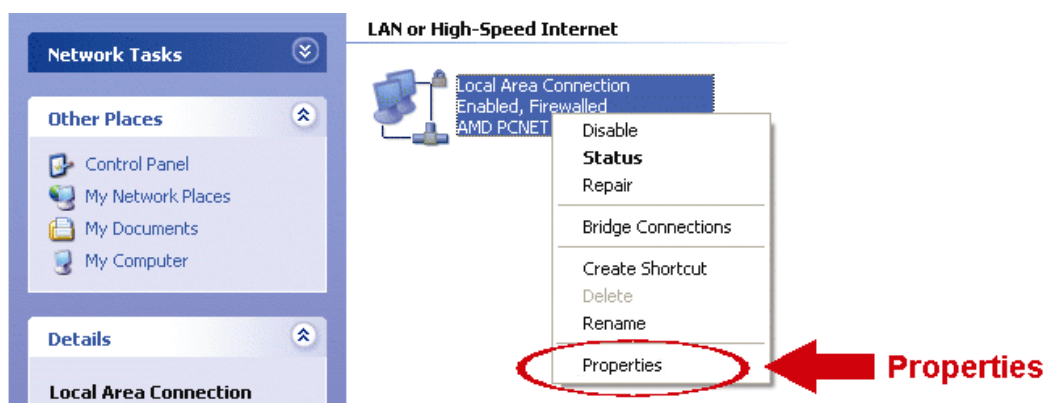

Note: If your local area connection is not enabled, please also enable it.

- c) In the “General” tab, select “Internet Protocol (TCP/IP)”, and select “Properties”.
d) In the “General” tab, select “Use the following IP address”, and set the IP address to “192.168.1.XXX” (XXX can be any value from 1~255 except 10).

Note: It’s recommended to note down the current settings first and then change as instructed. It’s helpful when you need to restore the PC network settings for connecting to Internet later.

- e) Click “OK” to close the “Internet Protocol (TCP/IP) Properties” dialog box. Then, click “Close” to close the “Local Area Connection Properties” dialog box.

For Windows Vista users:

- a) Select “

- b) Right-click on “Local Area Connection”, and select “Properties”.

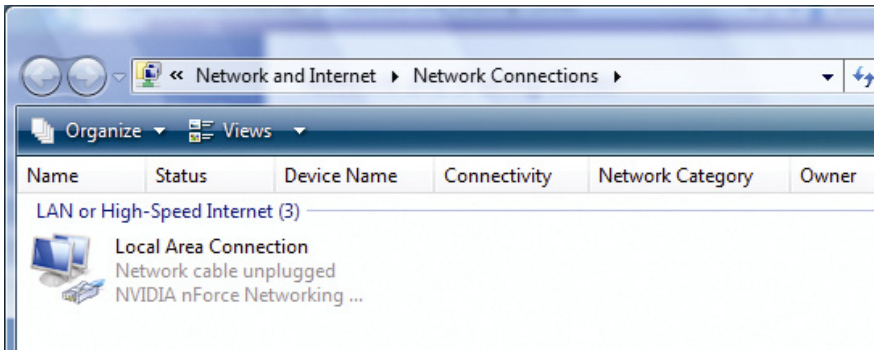

Note: If your local area connection is not enabled, please also enable it.

- c) In the “Networking” tab, select “Internet Protocol Version 4 (TCP/IPv4)”, and select “Properties”.
d) In the “General” tab, select “Use the following IP address”, and set the IP address as described below.

Note: It’s recommended to note down the current settings first and then change as instructed. It’s helpful when you need to restore the PC network settings for connecting to Internet later.

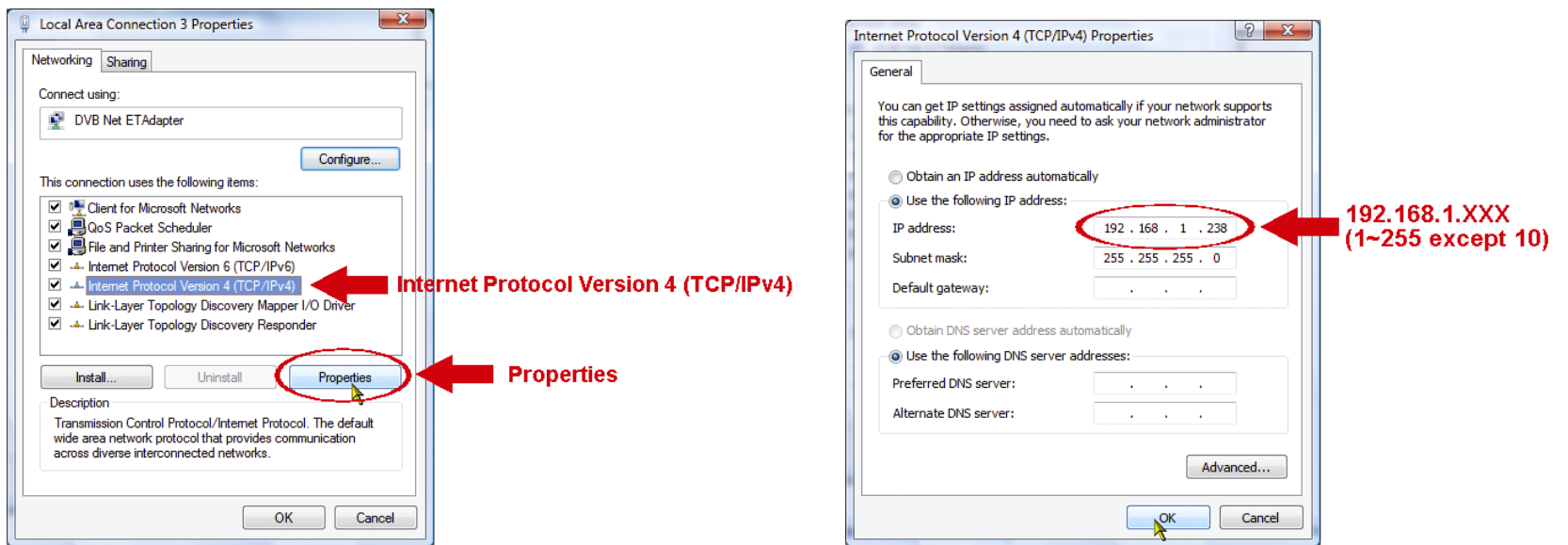

- e) Click “OK” to close the “Internet Protocol Version 4 (TCP/IPv4) Properties” dialog box. Then, click “Close” to close the “Local Area Connection Properties” dialog box.

For Windows 7 users:

- a) Select “

b) Right-click on “Local Area Connection”, and select “Properties”.

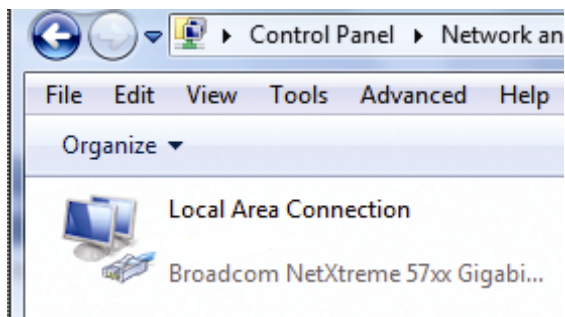

Note: If your local area connection is not enabled, please also enable it.

c) In the “Networking” tab, select “Internet Protocol Version 4 (TCP/IPv4)”, and select “Properties”.

d) In the “General” tab, select “Use the following IP address”, and set the IP address as described below.

Note: It’s recommended to note down the current settings first and then change as instructed. It’s helpful when you need to restore the PC network settings for connecting to Internet later.

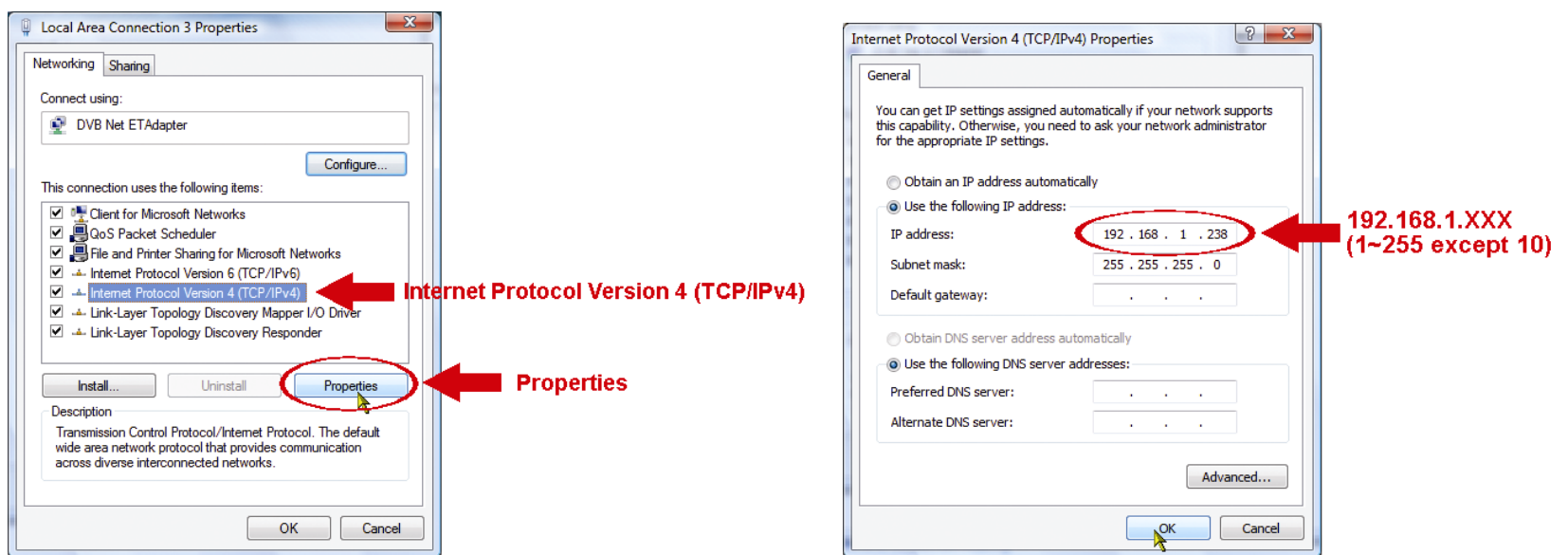

e) Click “OK” to close the “Internet Protocol Version 4 (TCP/IPv4) Properties” dialog box. Then, click “Close” to close the “Local Area Connection Properties” dialog box.

APPENDIX 2 MOBILE SURVEILLANCE VIA EAGLEEYES

EagleEyes is a mobile phone program used with our surveillance system for remote surveillance. It has several advantages:

- It's free (Except *EagleEyes Plus* for iPhone, *EagleEyesHD Plus* for iPad, and *EagleEyes(Plus+)* for Android mobile devices).
- It's compatible with several popular mobile platforms, such as iOS, Symbian, Windows Mobile, BlackBerry, and Android.

It's easy to download, install and configure. For more details about configuring and operating this program, please visit our official website www.eagleeyesccv.com.

A2.1 Prerequisites

Before installing *EagleEyes* to your mobile phone for remote surveillance, make sure you have checked the following:

- ✓ Your mobile platform is iPhone, iPad & Android.
- ✓ Mobile Internet services are subscribed and available to use for your mobile phone.

Note: You might be charged for Internet access via wireless or 3G networks. For the Internet access rate details, please check with your local network operator or service provider.

- ✓ You have noted down the IP address, port number, user name and password used to access your network camera from Internet.

A2.2 Where to download

Connect to www.eagleeyesccv.com from your mobile device, and sign in.

Note: Please **DO NOT** try to download *EagleEyes* from your computer.

Select the mobile platform you're using to enter its individual download page.

Note: You can also find *EagleEyes* on "App Store" / "Play Store" from your iOS / Android mobile devices.

When the download is completed, *EagleEyes* will be installed automatically to the location where all applications are saved in your phone by default, or where you specify.

APPENDIX 3 CONFIGURE PORT FORWARDING

You need to additionally access your router for port forwarding when your router doesn't support UPnP. Each router has different setting page. Here we're taking D-Link wireless router as an example.

Step1: Access your router for port forwarding.

- If you're configuring the camera with laptop / PC or iPhone / iPad over wireless network, open your web browser, e.g. Internet Explorer or Safari, and enter the IP address of your router.
- If you're configuring the camera with laptop / PC over LAN, disconnect the camera and connect to your router. Then, open your browser, e.g. Internet Explorer, and enter the IP address of your router.

Step2: In the router setting interface, go to the port forwarding (or virtual server) rule configuration page.

Note: The naming of port forwarding or virtual server may vary based on different router brands. To know where it is, please refer to the user manual of your router.

Then, enter the IP address and port number you set for the camera, and enable this rule.

Take D-Link router as an example:

Go to "ADVANCED" → "PORT FORWARDING".

The screenshot shows the D-Link DIR-635 router's web interface. The 'PORT FORWARDING' section is active, displaying a table of rules. The first rule is highlighted with a red box, showing the name 'my home', IP address '192.168.2.25', and ports to open '88' for both TCP and UDP. The 'Ports to Open' section is also highlighted with a red box, showing '88' for both TCP and UDP. The 'Application Name' and 'Computer Name' dropdown menus are also visible.

IP Address:	The IP address of this camera, such as 192.168.2.25.
Ports to Open:	The port number you set for this camera.